



Committed to People. Creating Safer Environments

8" Facial Recognition Thermometer Display



Automated Contactless Temperature Checking

Using Melexis thermal imaging technology, in conjunction with cooling fans to maximise accuracy, this complete solution can read a user's temperature and display the results in 1.8 seconds, even if they are wearing a mask. The automated nature of this system not only efficiently reduces manual labour, but also means it is completely contactless, which is of paramount importance in today's world.

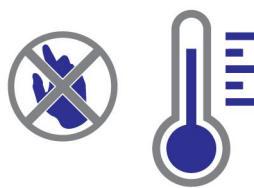

Contactless Temperature Display

High Security Facial Recognition

With 99.7% identification accuracy, this solution can also be used as a check in/out system for offices, warehouses and other secure locations. You can even create a whitelist and blacklist to control and restrict access, as well as recording all building entries. Adjust the identification security levels from using the photo on an ID card to high level military standard using a 3D face scan and body temperature check.

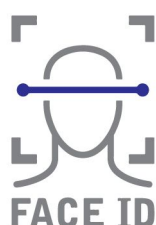
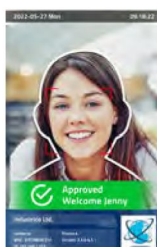

Strip-Light Indicator



Mask Detection System



Accurate Thermal Imaging



All-in-One Hardware/Software Solution



Synchronise with Existing Systems



Fever Alarm



Robust Metal Enclosure



Clock In/Out System



Various Mounting Options



Hand Sanitiser Add-On

Other Features

Mask Detection System

As well as reading body temperature, the system can also check if the user is wearing a mask if this is an entry requirement to your building. This feature can also be disabled if not required.



Works with protective face masks

Strip-Light Indicator

When taking a temperature or mask checking reading, this acts as on-camera illumination for more accurate results. It also synchronises with the software to indicate acceptance (green) or rejection (red) based on user-defined conditions.



All-in-One Solution

This is a full turnkey system, comprising of a 24/7 IPS panel, dual-lens optical facial recognition cameras, a thermal imaging module, an indication light, optional RFID/NFC integration and even the software to control, record and monitor all the functionality.



Synchronise with Existing Systems

Using the connection interface, this solution can be integrated with existing door or ticketing systems. Using the software included, you can stipulate entry conditions such as an acceptable temperature range, mask checking and specific user entry or restriction.



Automatically Open Doors

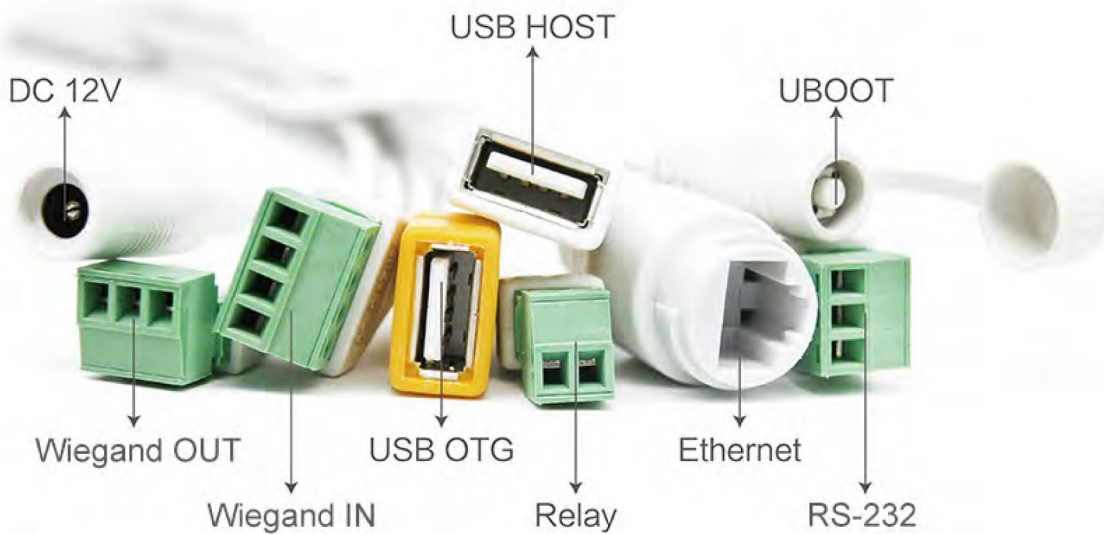

Other Features

Fever Alarm

When a user's temperature reading exceeds a stipulated temperature, a visual and audio alarm activate to alert the user that they have a fever. This feature can also be disabled if not required.



Optional NFC Integration

If you want to incorporate an ID card reader for building access you can do so. This feature can also be controlled and managed by the software that is included.



Software Included

The software is included at no extra cost and can be easily installed on your own PC or server to maximise security. Create separate login accounts with varying privileges, for example an account can be created for a receptionist to only register visitors. Can also work offline if required.

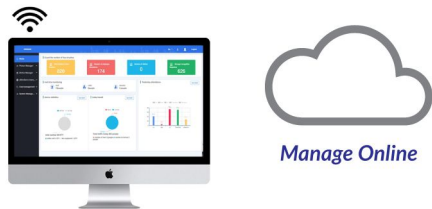

Accurate Thermal Imaging

Using a Melexis dual-chip system, the thermal imaging module measures the ambient temperature as well as the user's body temperature to maximise accuracy. The module also features a cooling fan to further improve the precision of the reading. The full sensor temperature range is -40°C to 85°C with an accuracy of $\pm 0.3^{\circ}\text{C}$.



Mounting Options

As standard this solution comes with an adjustable desk mounted pole. Optional mounting options include: a flush fit or adjustable wall mount, a desk stand, or a floor stand. All stand options have a modern integrated blue LED light strip.



24/7 Commercial Grade

This is a truly commercial grade solution as it can be in constant use around the clock. This is ideal for 24/7 commercial locations like supermarkets and gyms, as well as corporate and warehouse settings when used as a clocking in/out system.



Optional Automatic Hand Sanitiser

If you are utilising the floor stand, you can also add on an optional hand sanitiser dispenser to provide an extra level of safety.



Robust Metal Enclosure

To add to its commercial credentials, the enclosure is manufactured using aluminium rather than plastic as this is less likely to be damaged in locations such as warehouses and factory floors.



Key Features



THERMAL IMAGING COOLING FAN



THERMAL IMAGING MODULE



DUAL-LENS OPTICAL CAMERAS



24/7 IPS PANEL

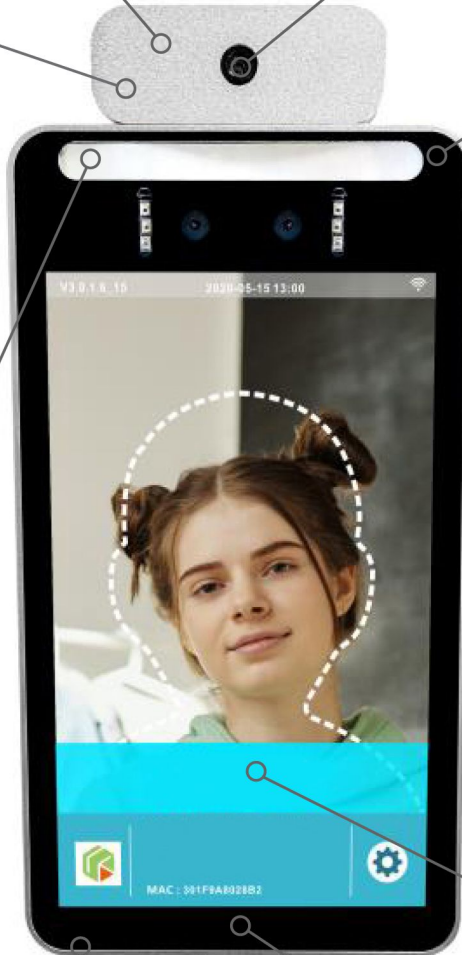

STRIP-LIGHT INDICATOR/
FLOOD LIGHT



ROBUST METAL ENCLOSURE



OPTIONAL NFC INTEGRATION



CUSTOMISABLE INTERFACE



MOUNTING/STAND
OPTIONS



SOFTWARE INCLUDED



CONNECTIVITY INTERFACE



HAND SANITISER ADD-ON

Specification Table



		8 Inch
Panel	Resolution	800x1280
	Display Area (mm)	107.62x172.18
	Aspect Ratio	10:16
	Brightness (cd/m ²)	450
	Colour	16.7M
	Viewing Angle	178°
	Contrast Ratio	5000:1
Optical Camera	Resolution	HD (2 million pixels)
	Type	Binocular dual-lens (wide dynamic camera)
	Aperture	F2.4
	Optimal Focus Range	50cm-1.5m
	White Balance	Auto
Thermal Imaging Module	Optimal Reading Distance	50cm-1m
	Measurement Accuracy	±0.3°C
	Measurement Range	10°C-42°C
	Thermal field of view	32°Cx32°C
Interface	Network Module	1 x Ethernet RJ-45 Port, WiFi
	USB	1 x USB OTG, 1 x USB HOST
	Serial	1 x RS-232 serial port
	Relay	1 x Output
	Wiegand	1 x Input, 1 x Output
Software	Temperature Alarm	Optional
	Face Library	30,000
	Facial Recognition Security	Level 1-4
	1:N Facial Recognition	Supported
	1:1 Face Comparison	Supported
	Firmware Upgrades	Supported
Mechanical	Unit Size (WxHxD mm)	132.88x296.18x25
	Package Size (WxHxD mm)	180x430x120
	Net Weight (kg)	1.5
	Gross Weight (kg)	4
Computer	CPU	RK3288 quad-core
	Operating System	Android 7.1.2
	Storage	EMMC 8G
Audio	Speaker Type	2.5W, 4Ω (x2)
Power	Power Consumption (W)	13.5 (Maximum)
	Input Voltage	DC12V
Environmental	Operating Temperature	0 °C to 60 °C
	Storage Temperature	-20°C to 60°C
	Operating Humidity	10% to 80%
	Storage Humidity	5% to 95%
Accessories	Included	Scheduling Software, Remote Control, User Manual, Charger, Mains Power Cable
	Optional	Network Upgrade, Security Chain
Standards	Certification	CE, FCC & ROHS
Warranty	Warranty Period	3 Year Warranty
	Technical Support	Lifetime

Errors and omissions excepted



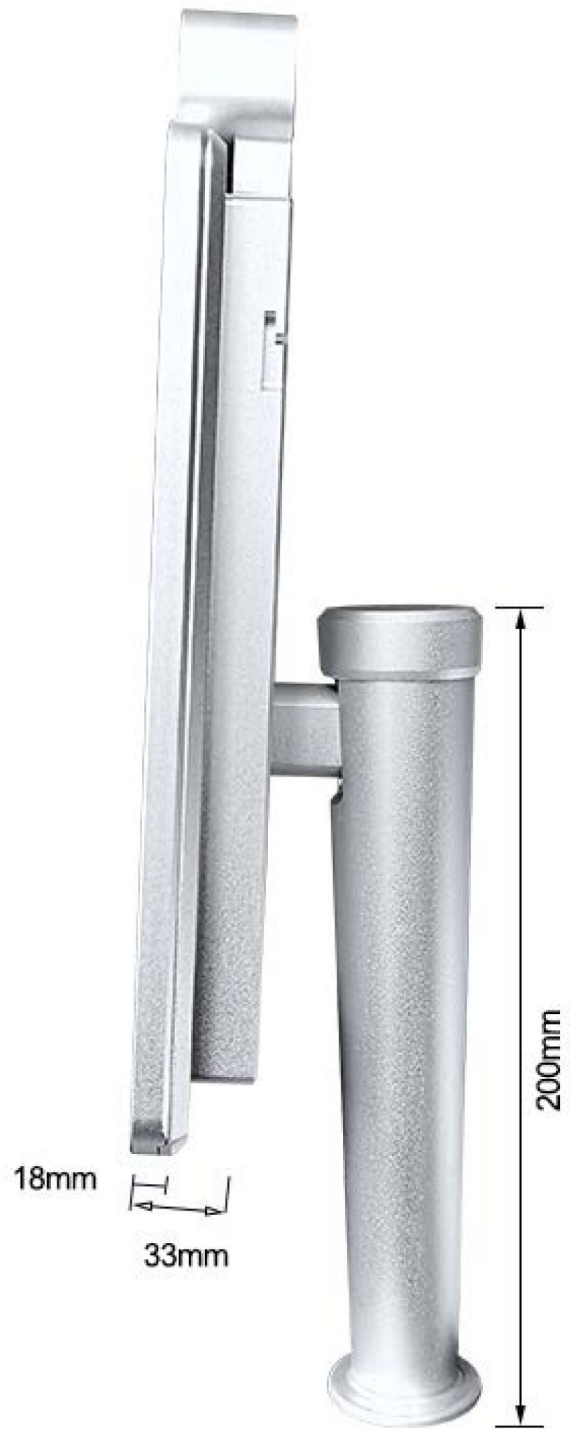

TX TECHNOLOGY PRIVATE LTD

India Corporate Office Address

19/48, Malcha Marg, Chanakya Puri,
New Delhi 110021, (INDIA)

Phone

+91- 9811 050 484

Website

www.txtechnology.co.in

Email

info@txtechnology.co.in

Toll-free No.

+1800 8916 589

